

hardware guide

pro & gx range

Contents

Welcome.....	2
4x4pro Front panel.....	3
2x4pro/gx 2 Front panel.....	4
gx 1 Front panel.....	5
Rear panels.....	6-7
Powering your pro/gx server.....	8
Quick start.....	9
VFC cards.....	10
Changing VFC cards.....	11-14
Support.....	15-17

Welcome

Your new disguise server is just minutes away from being setup and ready to go. Please read the instructions in this hardware guide carefully in order to understand how to work with your machine.

You can also refer to the online guides at help.disguise.one

The pro range is disguise's cutting edge solution for large and complex shows. The pro range, 4x4pro and 2x4pro set a standard for power and flexibility. They are suited for the most demanding touring productions, massive multi-projector shows, TV, broadcast and high-quality fixed installs. They also give users the option to change the video output signal through Video Format Conversion cards (VFC), so shows can be delivered with fewer machines, no downstream splitters and practically no latency.

The gx range is the natural evolution of the pro range due to the current demand for real-time generative content in the shows of today and the future. Providing the same rugged touring chassis that we have built and developed over the years but with a little extra power to push those generative effects. The industry first, patented Video Format Conversions cards (VFC) are fully compatible across the complete pro and gx series.

We put great care and effort into the development and manufacture of our products. Please contact your Sales team or the Support team if you experience any issues with this product. Contact details can be found at the end of this booklet.

If you have any questions or feedback for us, we'd be happy to hear from you.

The team at disguise

Front panels

4x4pro front panel

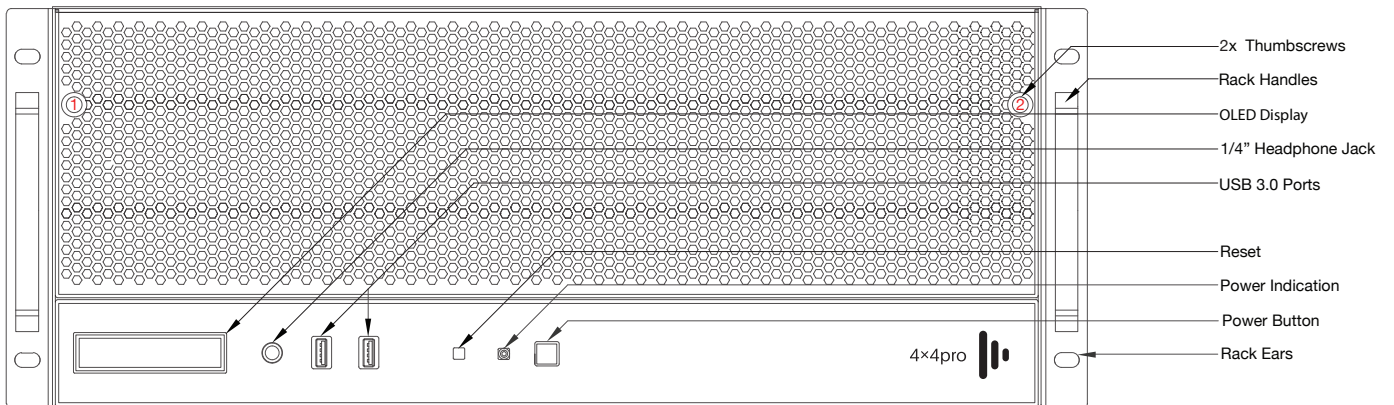

To reveal the drive bay and to inspect the air filter undo the two thumb screws on the front of the unit (1 & 2)

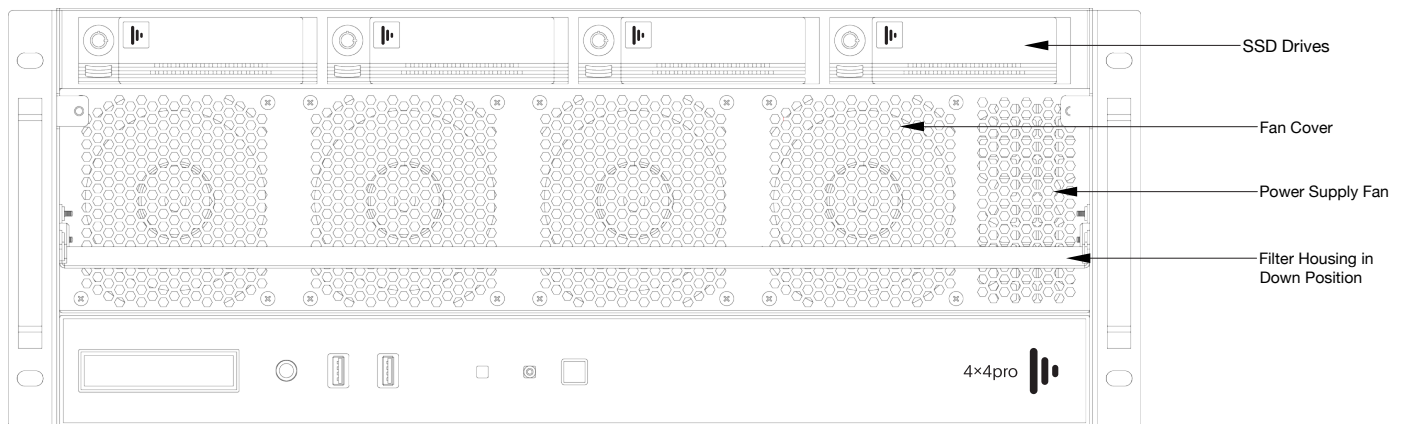

* The 4x4pro comes with 4x SSD drives. For more info on hard drive configuration refer to the online hardware guide.

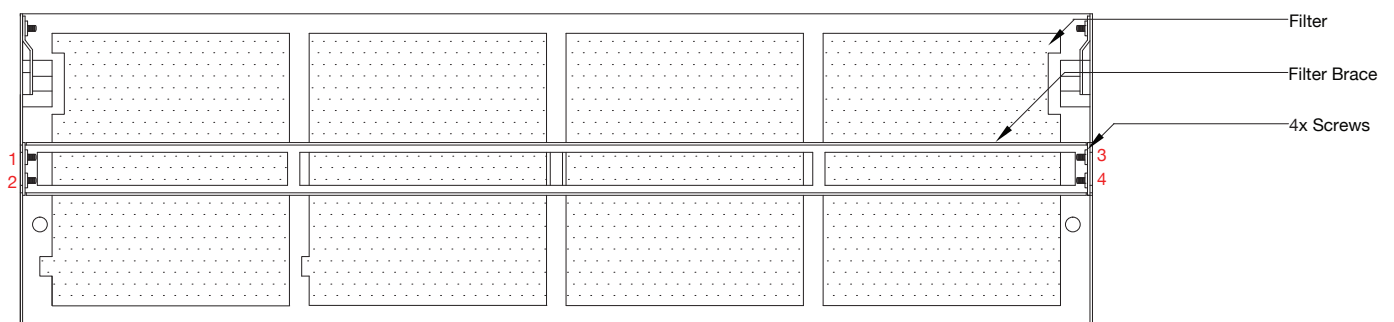

You should regularly inspect the air filter on the front of the unit to prevent loss of cooling efficiency. To remove the air filter material, first remove the screws from the filter housing marked as in the diagram above. Give the filter a clean, replace the filter in the metal frame and reattach the filter brace.

2x4pro/gx 2 front panel

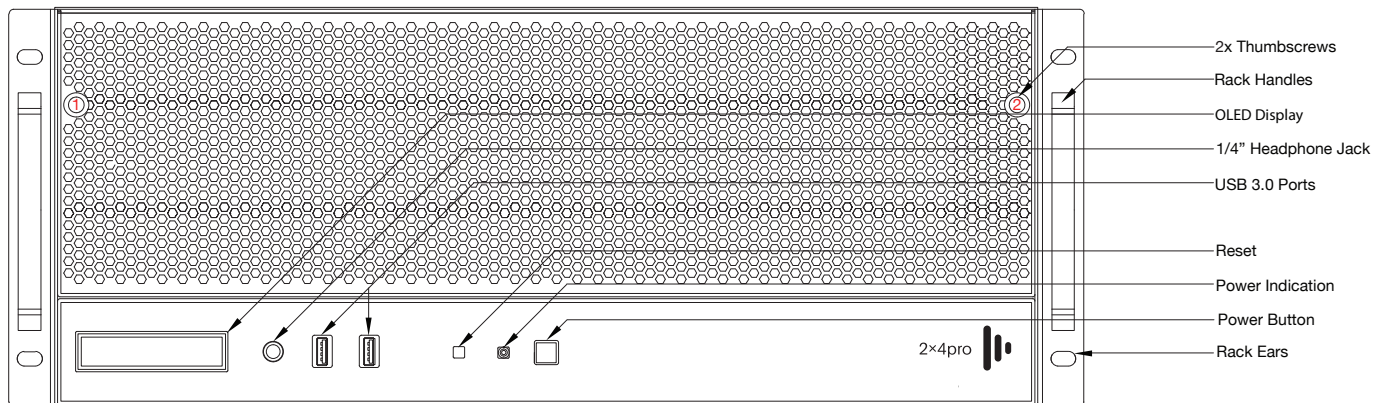

To inspect the air filter undo the two thumb screws on the front of the unit (1 & 2)

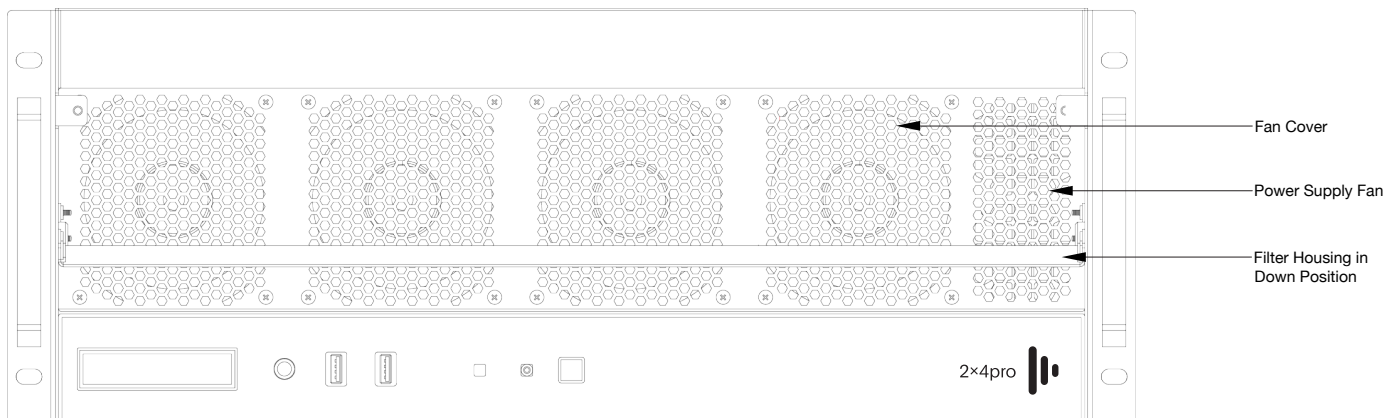

* The 2x4pro/gx 2 comes with 1 internal storage drive. For more info on hard drive configuration refer to the online hardware guide

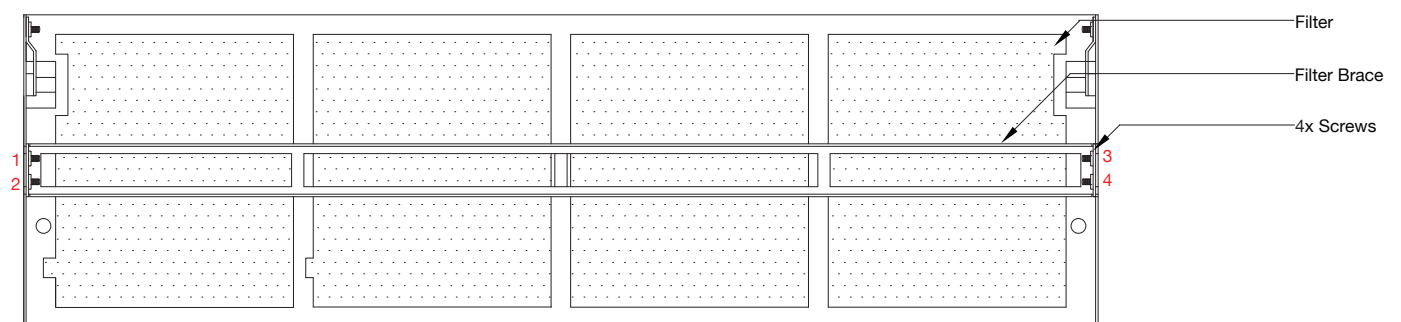

You should regularly inspect the air filter on the front of the unit to prevent loss of cooling efficiency. To remove the air filter material, first remove the screws from the filter housing marked as in the diagram above. Give the filter a clean, replace the filter in the metal frame and reattach the filter brace.

gx 1 front panel

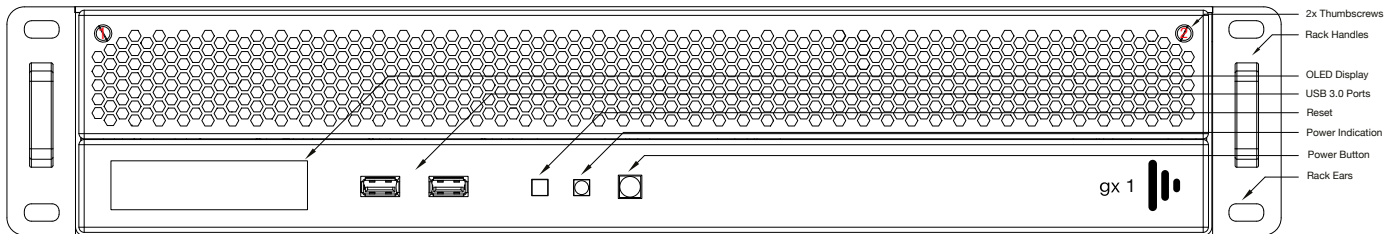

To inspect the air filter undo the two thumb screws on the front of the unit (1 & 2)

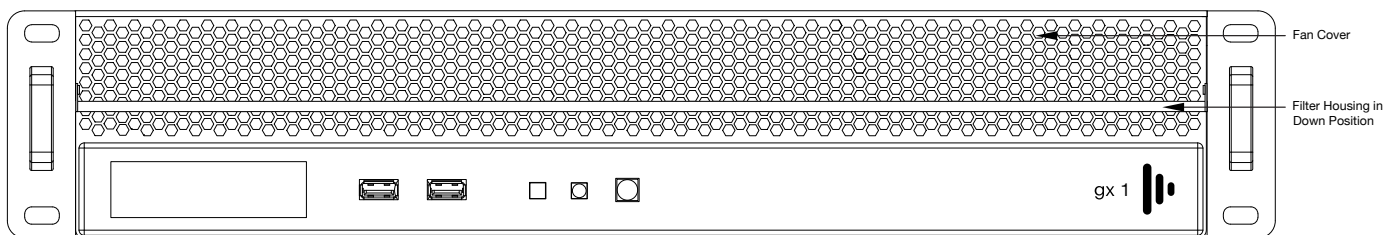

* The gx 1 comes with 1 internal storage drive.

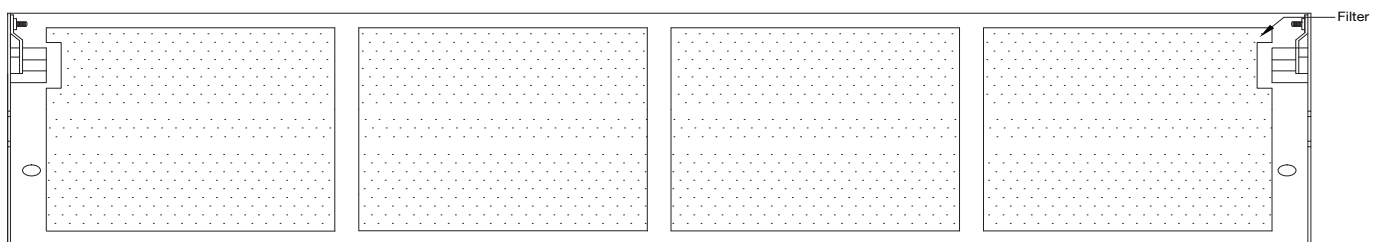

You should regularly inspect the air filter on the front of the unit to prevent loss of cooling efficiency. To remove the air filter material carefully unclip the filter from its holding tags. Give the filter a clean and replace the filter in the metal frame.

Rear panels

4x4pro back plane

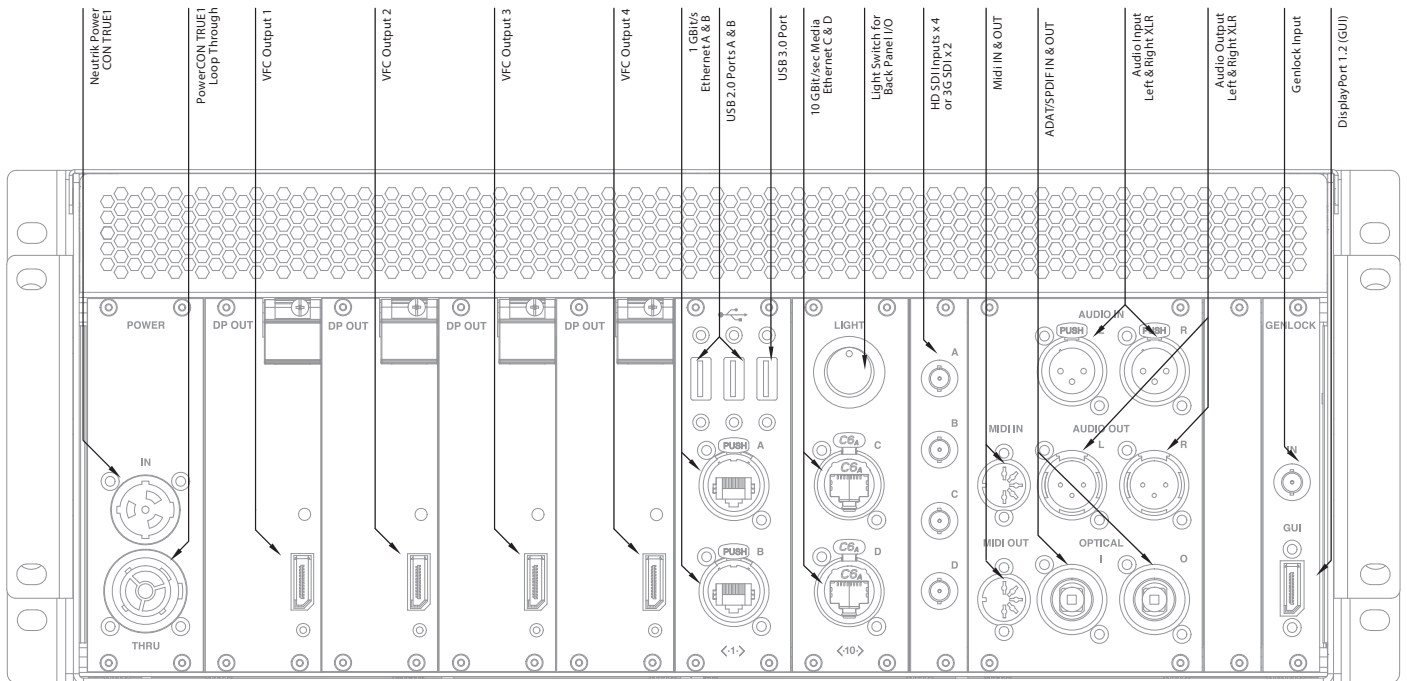

2x4pro/gx 2

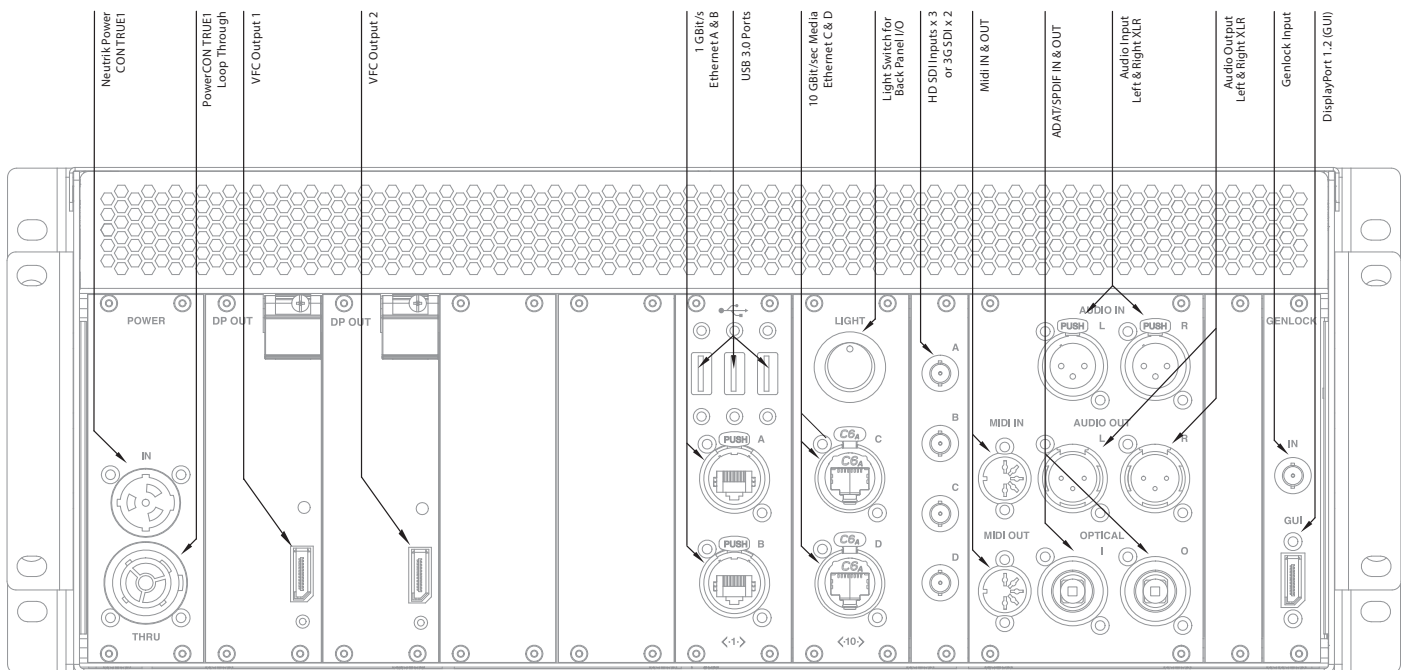

gx 1

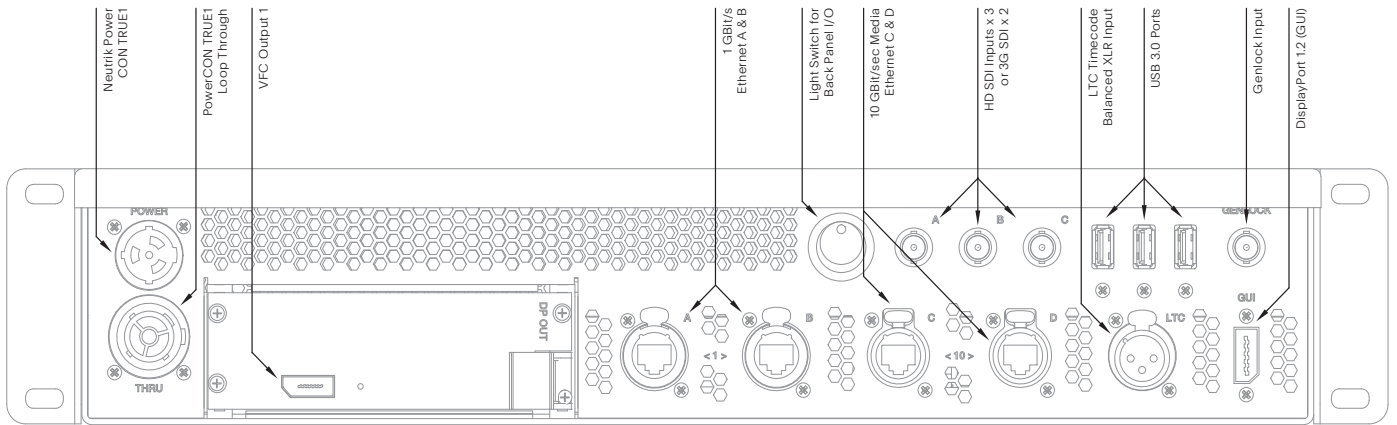

Powering your server

The pro and gx range uses the Neutrik powerCON TRUE1 as its power input. This mains connector is:

- Lockable
- Live-Mating (safely)
- Extendable
- Dust and water resistant

To power the server you should use a cable with the following attributes:

- SJT flexible cord, min. 12AWG, min. 300V, min. 60°C, max 4.5 m long
- One end terminated with NEMA 5-15P/BS 1363/CEE 7/7 plug
- Other end terminated with appliance coupler type Neutrik NAC3FX

Powering a Multi Server System

disguise servers feature a power pass-through, making it possible to connect multiple systems.

The power input to the machine is rated at 12Amps RMS per connection in Europe and USA.

Loop through cables should have the following attributes:

- SJT flexible cord, min. 12AWG, min. 300V, min. 60°C, max 4.5m long
- One end terminated with appliance coupler type Neutrik NAC3MX-W
- Other end terminated with appliance coupler type Neutrik NAC3FX

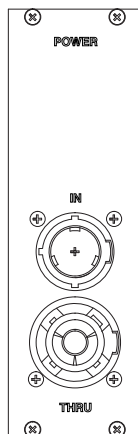

True1 Powercon and Loop Through connections on rear of unit

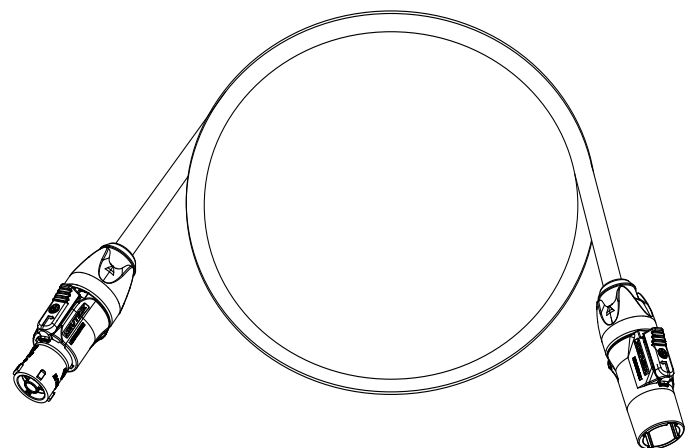

Power cable daisy chain

Quick start

1. Make sure you have connected a keyboard, mouse, monitor and speakers as shown below.

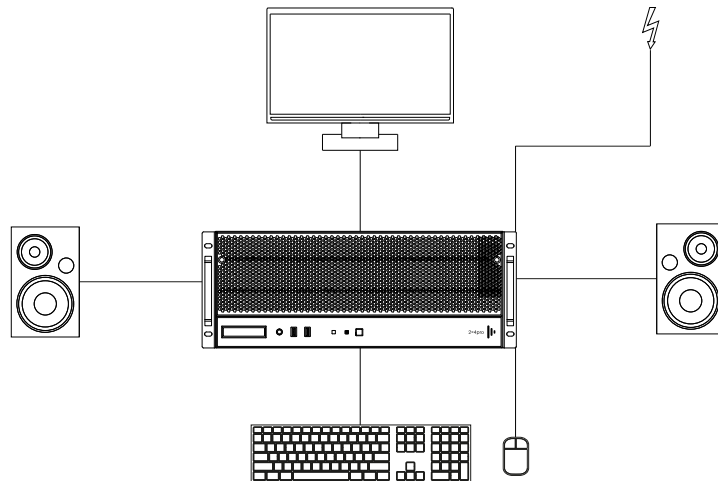

disguise unit connected to peripherals

2. Units in the pro and gx range are fitted with Neutrik powerCON TRUE1 connectors as standard.

3. Use the included power cable with the Neutrik powerCON TRUE1 connector to connect the unit to a power source.

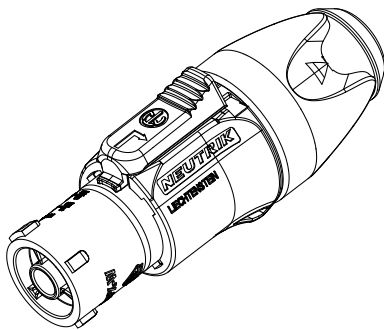

Neutrik powerCON TRUE1 connector

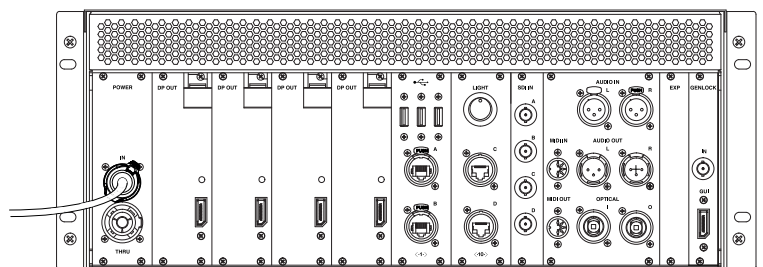

Unit connected to power source

4. Press the power button on the front panel of the unit and wait for the system to boot.

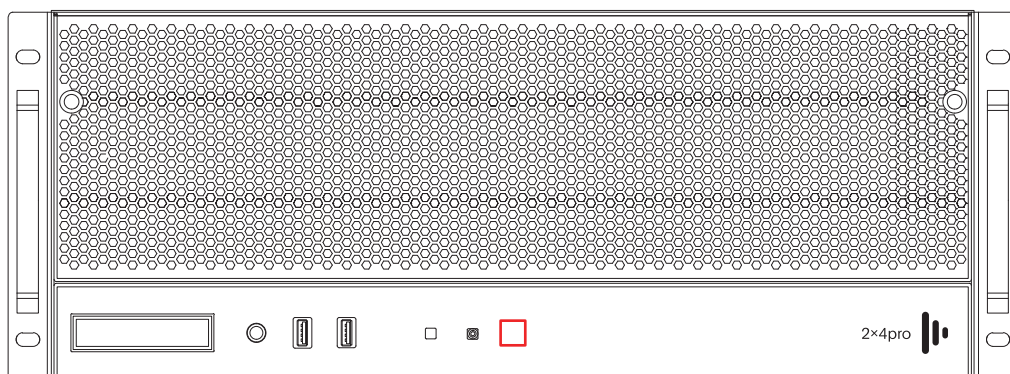

Location of Power on/off button on front of unit

VFC cards

The pro and gx ranges ship standard with DisplayPort 1.2 outputs, giving you 4K outputs plus an extra output for your control GUI. Quad-DVI and Quad-SDI cards are available as accessories, allowing you to change cards as your production demands it.

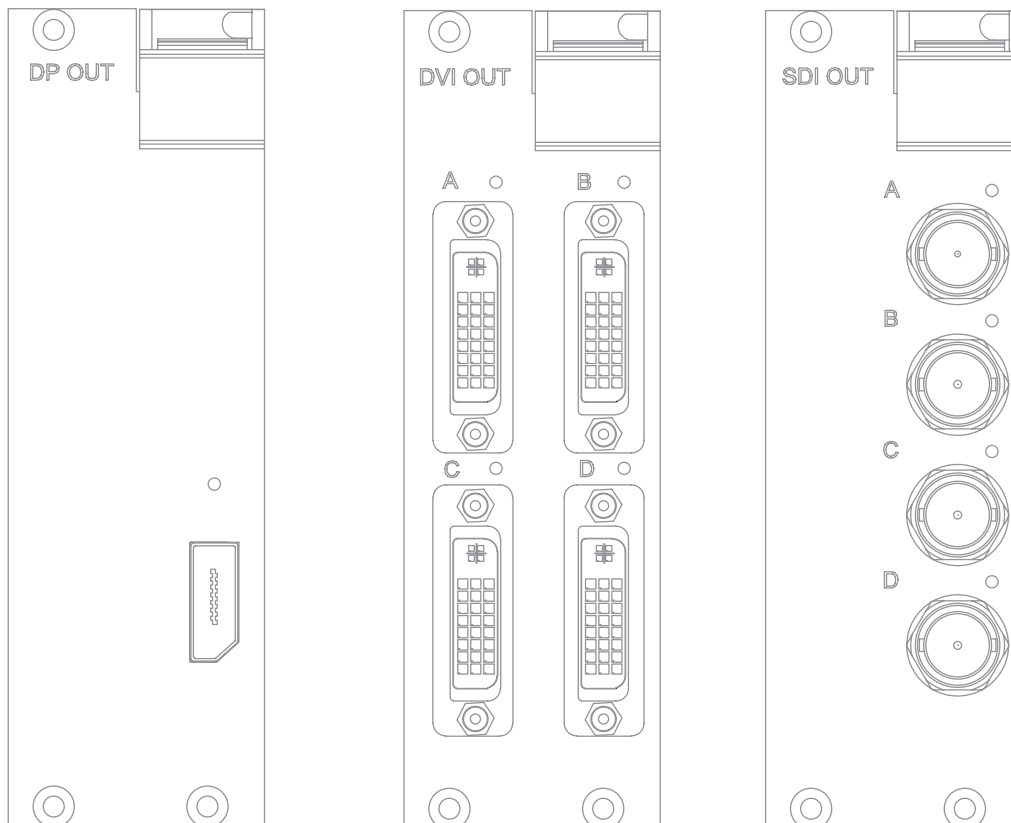

Shown from left to right: DP 1.2, Quad-DVI, Quad-SDI

VFC Card combinations:

The pro and gx range can combine the above cards in a range of combinations as shown below.

2×4pro - Combination of any two cards at one time.

4×4pro - Combination of any four cards at one time.

gx 1 - Single card at one time.

gx 2 - Combination of any two cards at one time.

Changing VFC cards

Please note: Take steps to ensure you are free of static electricity before starting the procedure and ground yourself appropriately. We recommend the use of an anti-static wrist strap as well as an anti-static mat if one is available. It is easiest to change the cards starting on the right hand side, and it is advised to do so regardless of the amount of cards you need to change.

Users can change VFC cards as they require. You can replace one or multiple cards. The following steps are a guide to help users change over VFC cards. Please read carefully to ensure best practice. If the system does not work after following these instructions, do not force the VFC cards but call our Support team as per the contact details on the last page of this document.

Step 1: Disconnect the system from all sources of power: remove the power cord from input and output, before changing the VFC cards.

Step 2: Using a Phillips #1 screwdriver loosen the 4× retaining screws on the VFC card you want to replace. The screws are indicated with a red line in the image below.

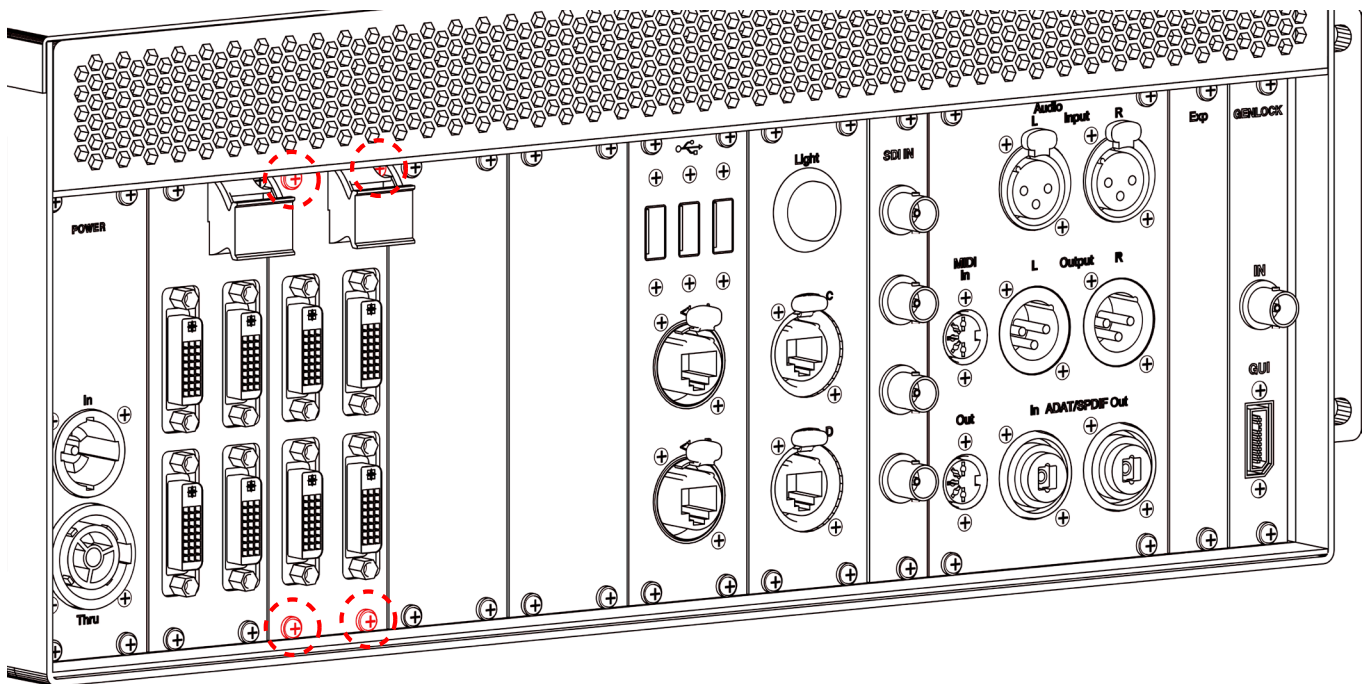

Red lines indicate screw location. Example shows Quad DVI VFC cards

Step 3: Lift the latch on the top right corner of the card and gently remove the card from the rear of the unit by pulling gently as shown in the images below.

Please note: The VFC cards are fragile, be sure to pull straight not flexing the card and if under any resistance do not use excessive force. Avoid touching the exposed electronics.

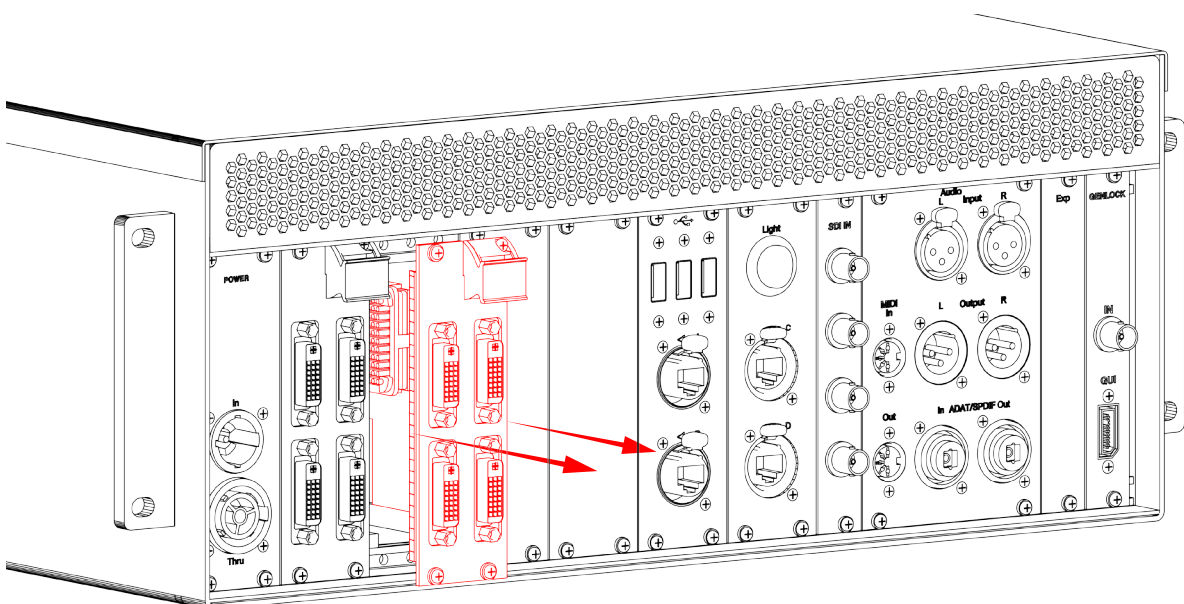
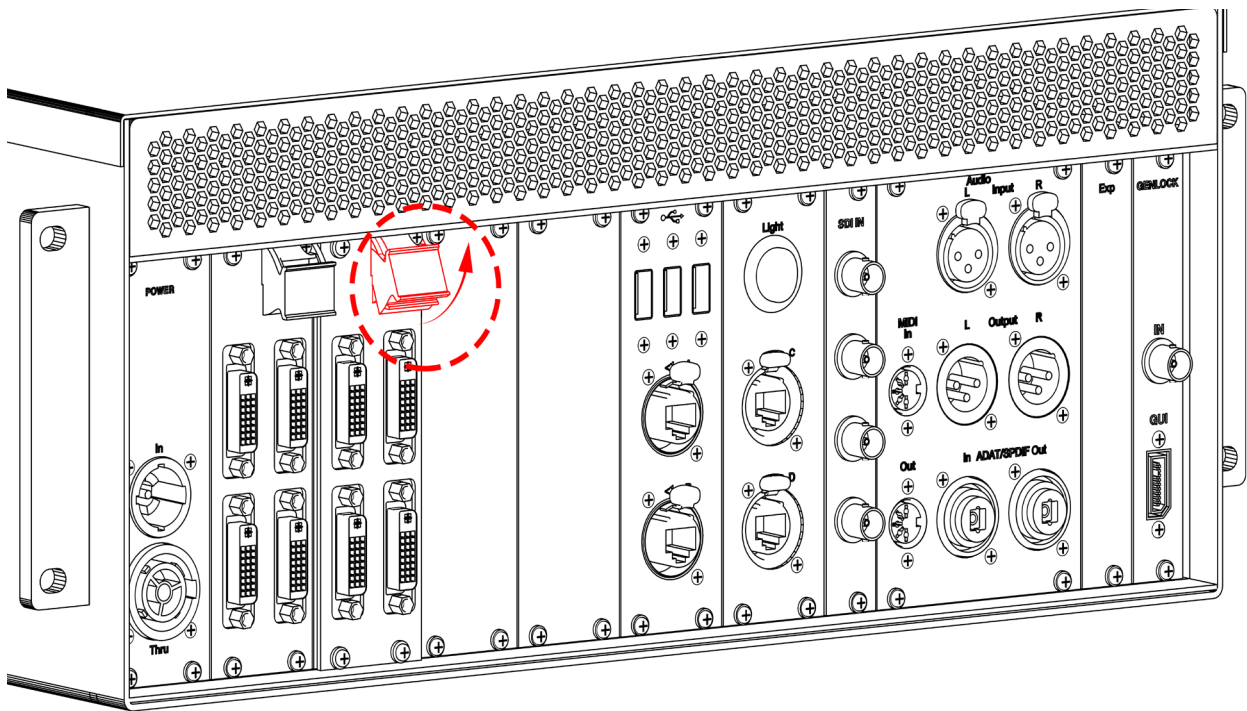

Step 4: Gently place the removed card into the anti static box provided with your purchase.

Step 5: Gently insert the new VFC card into the vacant slot, being careful to line the card up with the guides both at the top and the bottom of the system, as indicated for the bottom with red lines in the image below.

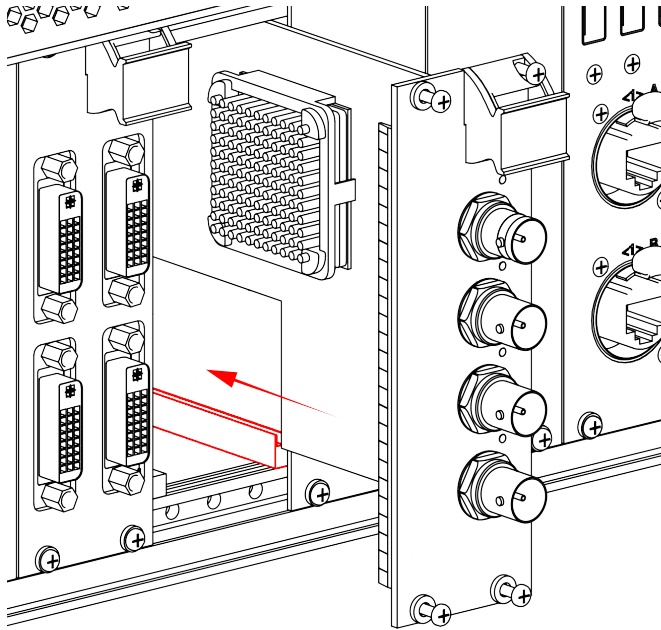

1 - EMC Gasket

Please note: The top and bottom of the card needs to slide into the guides. Be sure that the grounding spring maintains its fixed position to avoid jamming when re-inserting.

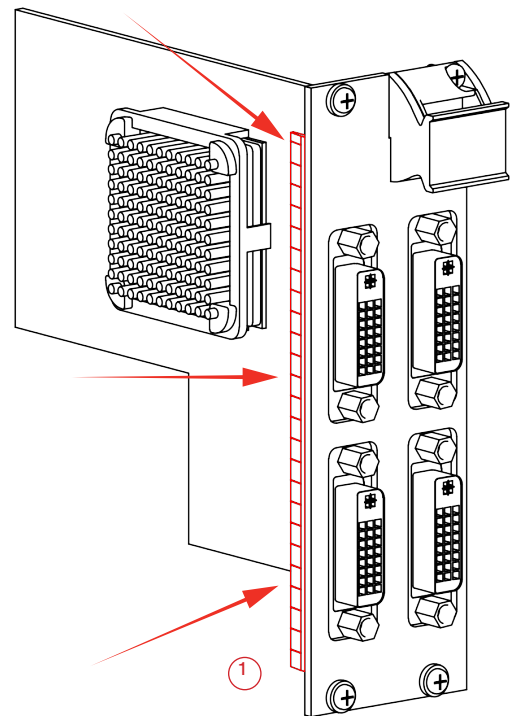

gx 1: With the gx 1, ensure that the latch is on the right when inserting a card. The plastic guides are located near the base of the server and help align the card with the connector.

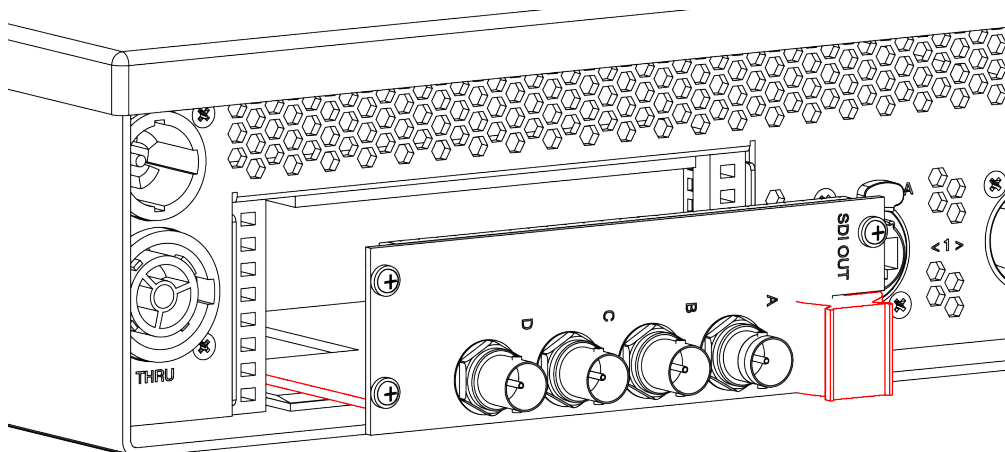

Step 6: Once inserted into the guides, make sure the card is fully flush with the rear of the server by gently and firmly pressing in the centre of the VFC card, as indicated in the image below.

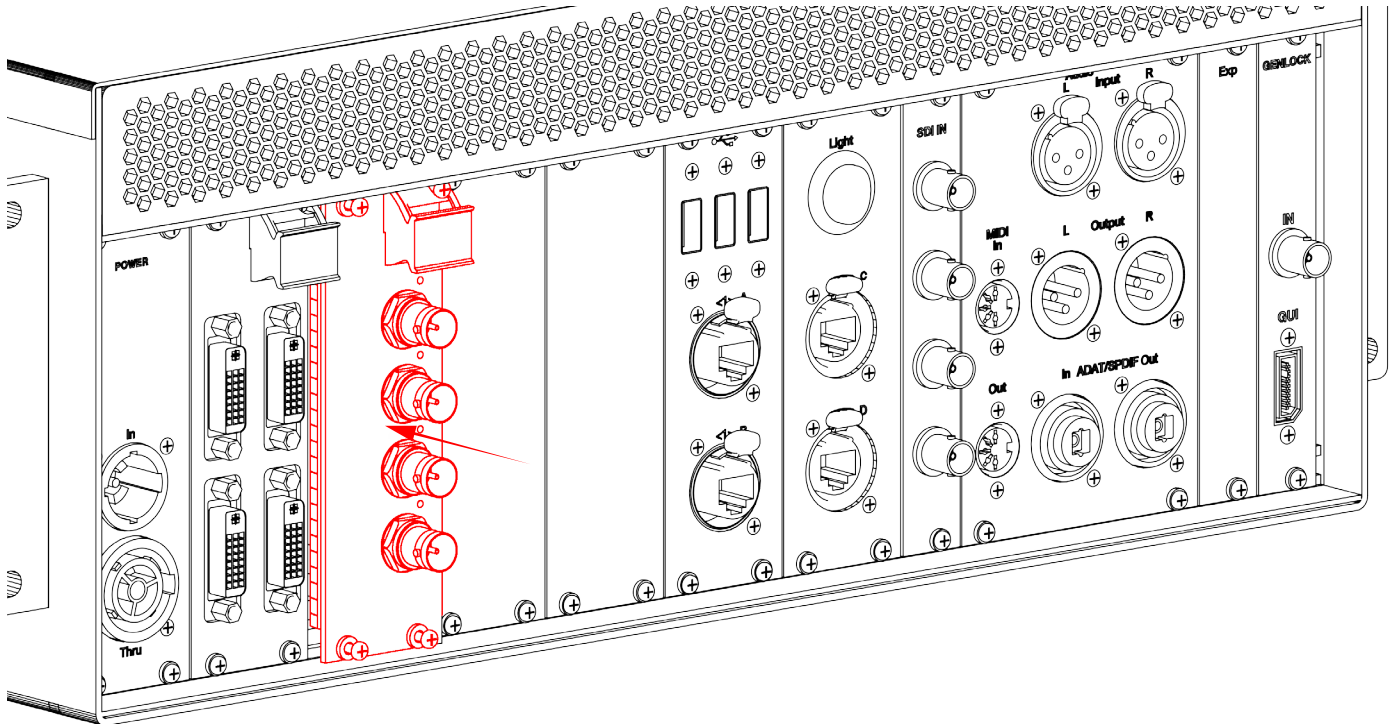

Step 7: Fasten the four retaining screws before repeating all of the steps for the next card. To reduce the risk of damaging the threads, do not apply excessive torque to the screws.

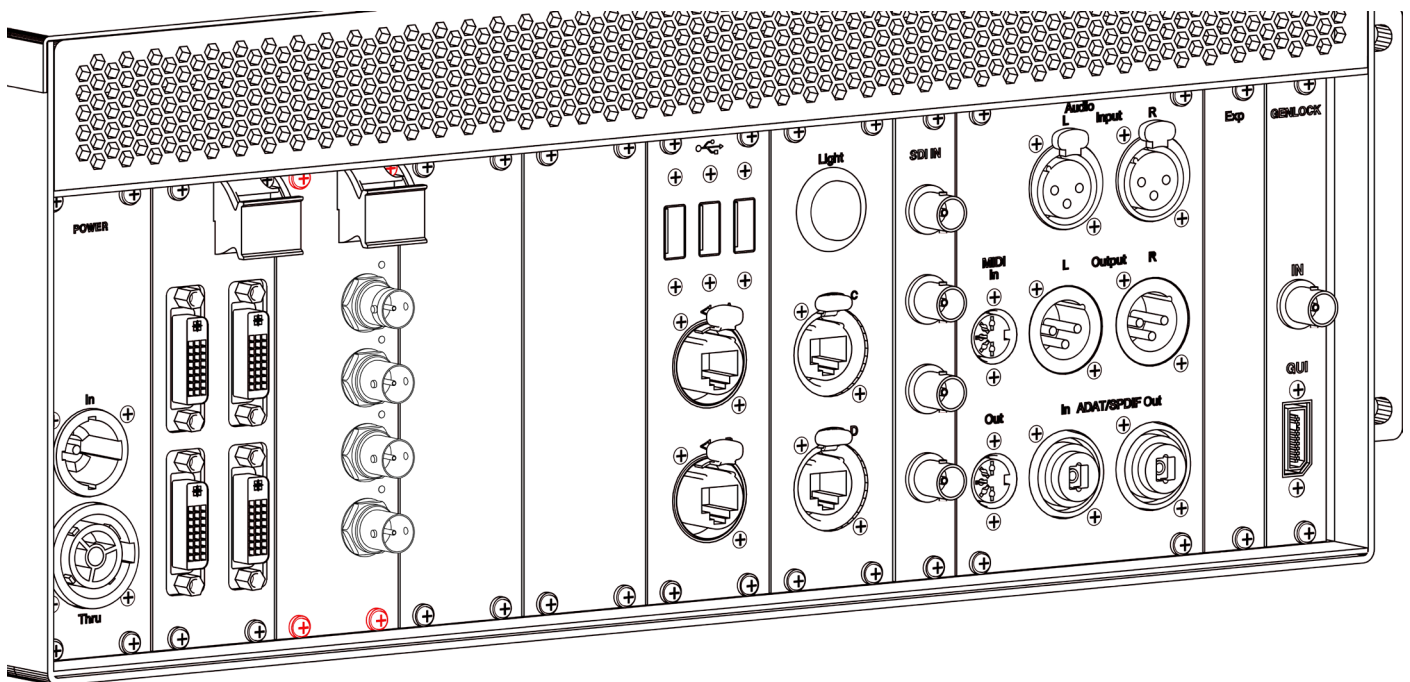

Support

Helpful contacts

Support Team

support@disguise.one

Training Team

training@disguise.one

Sales Team

sales@disguise.one

Helpful links

User Guide

help.disguise.one

Trial

disguise.one/en/get-disguise/get-trial

Software Updates

disguise.one/download-disguise

Additional Designer licenses

store.disguise.one